

DUAL DIGITAL CONTROLS

Control temperature, time, chromotherapy and reading lights inside or outside your sauna with dual redundant controls.

ELEGANT DETAILS

Beautiful tongue and groove wood and attention to detail set our furniture quality sauna cabins apart.

LOW EMF / LOW ELF

The safest and most effective saunas available with Ultra Low EMF / Low ELF technology.



BEAUTIFUL ACCENT LIGHTS

Energy efficient LED lights highlight the beauty of your sauna while providing gentle ambient lighting.

THERAPEUTIC FAR INFRARED HEATERS

Our exclusive True Wave™ hybrid Carbon & Ceramic low EMF far infrared heaters surround you in healing infrared heat.

DOCTOR DESIGNED ERGONOMIC BENCH

Relax in comfort in your sauna with our reversible bench. The extra deep bench is ergonomic on one side and flat on the other for maximum comfort. You can flip the bench at any time.

ENHANCED AUDIO SOUND SYSTEM



Bluetooth and AUX inputs make it easy to connect and listen to your audio devices.

BEAUTIFUL WOODEN LIGHT SHADE



Your sauna sessions are enhanced with the relaxing inside light for that true sauna feel.

BUILT-IN ERGONOMIC BACKREST



Relax close to the soothing infrared heat against the Chiropractor designed built-in ergonomic backrest.

EXCLUSIVE UNDER FLOOR HEATER



Only Clearlight Premier Saunas include a heater underneath the wood floor to enhance your sauna session.

SPECIFICATIONS

Construction

Eco Certified Grade "A" Clear Western Red Canadian Cedar
6 mm safety glass
Weight: 147 kg

Exterior

Width: 102 cm
Depth: 112 cm
Height: 193 cm

Interior

Width: 89 cm
Depth: 102 cm
Height: 180 cm
Bench: 84 cm x 56 cm

Far Infrared Heaters

True Wave™ Carbon & Ceramic Low EMF/ELF Heaters
Power: 230V / 1,410W / 7A

Full Lifetime Warranty

Comes with standard chromotherapy, upgrade possible.

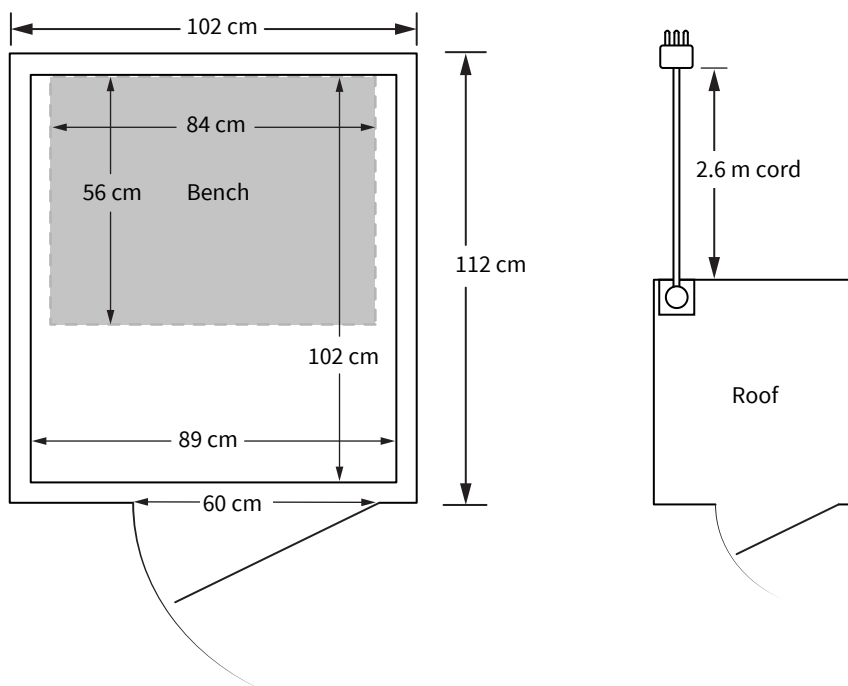
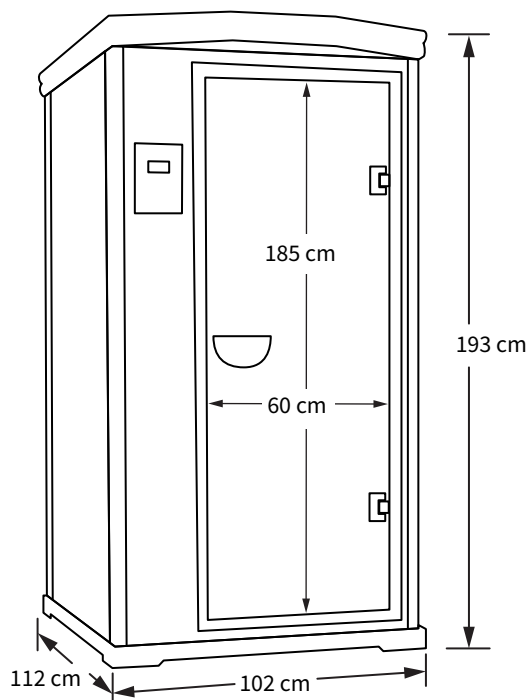

SPECIFICATIONS

Construction

Eco Certified Grade "A" Clear
Western Red Canadian Cedar
6 mm safety glass
Weight: 147 kg

Exterior

Width: 102 cm
Depth: 112 cm
Height: 193 cm

Interior

Width: 89 cm
Depth: 102 cm
Height: 180 cm
Bench: 84 cm x 56 cm

Far Infrared Heaters

True Wave™ Carbon & Ceramic
Low EMF/ELF Heaters
Power: 230V / 1,410W / 7A

Full Lifetime Warranty

Comes with standard
chromotherapy,
upgrade possible.